

# Tecomotive - tinyCWA - User Manual

## Overview

### Contents

- tinyCWA controller
- Fuse holder
- Fuse(s)
- Connector 8 pin (controller)
- Connector 3/4 pin (water pump)
- Connector 2 pin (temperature sensor)
- Temperature sensor M12x1.5
- Set of screws (controller mounting) (see next page)

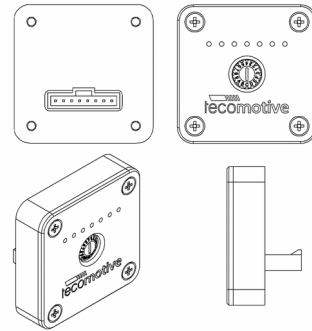

### Introduction

The Pierburg CWA200 was the first electronic water pump for line production introduced by BMW in 2004. They are now widely available in used cars / the aftermarket and have many advantages over conventional mechanical pumps. Some of which are the freedom of installation and the independence of engine revolutions. Also the pumps are very well built and with its brushless canned motor they are practical maintenance free.

The “tinyCWA” controller can control those and all other CWA type pumps in the appropriate manner.

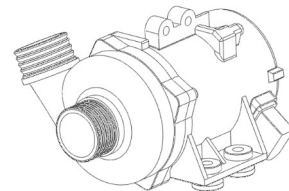

### Operation

When activated the controller is measuring the coolant temperature and the rate of increase with the connected temperature sensor. With this data it then calculates the appropriate water flow and sends a signal to the pump where the internal pump electronics then set it to the right speed. This way you will always have the right pump speed for any circumstances.

### Features

- Simple to set up with only one rotary switch
- Choose your favorite target temperature from 15°C to 100°C (59°F to 212°F)
- LED display shows the current pump speed or rough coolant temperature
- Compact and robust anodized aluminum case
- Relay output for the radiator fan (recommend to use)
- Delayed shutdown of the pump and the fan after ignition turned off
- Manually control the pump speed (e.g. for bleeding or testing)
- LED warning system and various safety features
- **Beta:** Possibility of controlling a Mercedes type PWM fan via the tinyCWA fan output (10Hz PWM) (See page 12 for more information)



Manual: Archive / PDF version  
[www.tecomotive.com/archive/tinycwa](http://www.tecomotive.com/archive/tinycwa)

## Installation

### Installation drawing (mm)

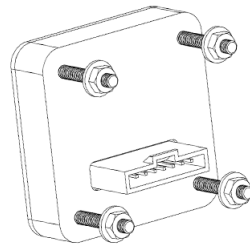
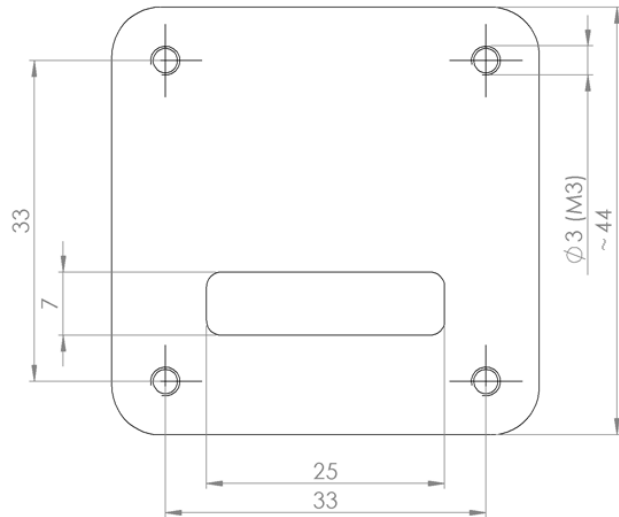

### Changing the screws

To mount the controller on a front panel you can change the four case screws (M3) to the longer ones which come with the kit.

Please only change one at the time. There are little spacers inside the case which can get out of place without the screws. (See the picture at the first page)

Of course the controller can be mounted anyway you like. (E.g. with double sided tape or zip ties ...)

## Connection

We made the connection as easy and intuitive as possible. So in general that means that the same color cables are meant to connect to each other. Detailed connection diagrams can be found on the last pages.

Even though the pumps are electronically regulated you should always use the fuse / fuse holder that comes with the kit.

### Connector: Controller (8 pin)

**Info:** If you do not want to use the delayed shutdown function you can connect the red wire (pin 2) to the ignition switch, too.

**Attention:** The radiator fan relay output can only handle a maximum of 0.4 amps! (That means a minimum of 37 ohms coil resistance)

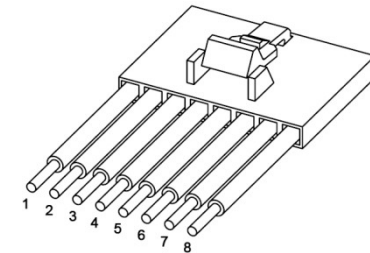

PIN	Color	Funktion
1	Black	Ground GND -
2	Red	Battery +
3	Yellow	Ignition key +
4	Black	Additional ground GND for temperature sensor
5	Orange	Signal wire temperature sensor
6	Blue	Radiator fan relay output
7	Grey / Red	Signal positive wire water pump
8	Grey / Black	Signal ground wire water pump

**Beta:** Possibility of controlling a Mercedes type 10Hz PWM fan by wiring pin 6 (blue) to the signal input of the fan controller (LES).

### Connector: Water pump (4 pin)

**Info:** If you do not want to use the delayed shutdown function you can connect the red wire (pin 1) via an ignition switched relay.

**Attention:** The main current flows through pin 1 and pin 4. (CWA200)

Please only use wires which are able to handle the current!

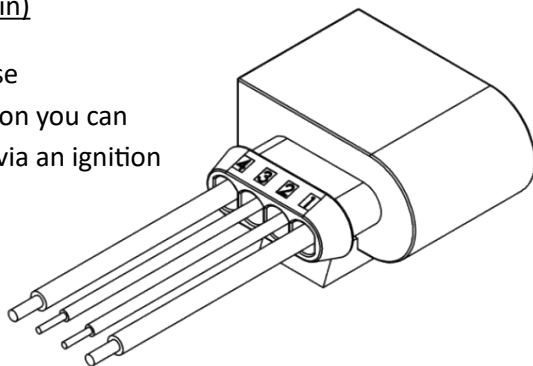

Fuses: (CWA50 7.5A / CWA100 15A / CWA200 20A / CWA400 40A)

You will find the pin-out of the other pumps at the end of this manual.

PIN	Color	Connection
1	Red	Battery +
2	Grey / Red	Signal wire from controller
3	Grey / Black	Ground wire from controller
4	Black	Ground GND

### Connector: Temperature sensor (2 pin)

(Not needed in manual mode (see page 8-9))

PIN	Color	Connection
1	Orange	Signal
2	Black	Ground GND

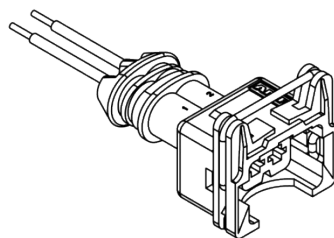

### Water pump installation

In and outlet of the pump are shown in the picture.

You can draw the water out of the bottom radiator port and then pump it back into the engine. But the other way around is possible, too.

Also it may be helpful to mount the pump as low as possible.

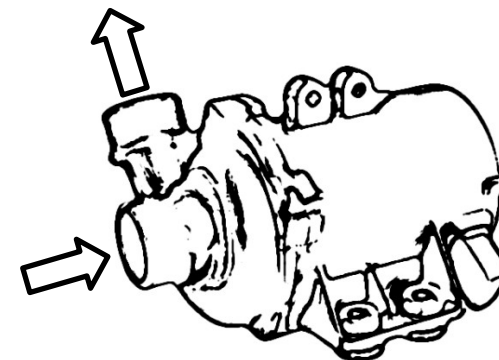

**Attention:** Please only mount the pump with appropriate rubber dampers because high vibration can damage the internal electronics!

### Placing the temperature sensor

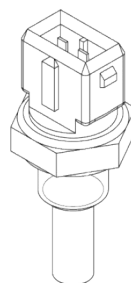

The temperature sensor is a standard Bosch type NTC used in many European line production cars. It's got a M12x1.5 thread and a copper ring for proper sealing.

**Attention:** You should position the sensor at the hottest place of your cooling system.

If you use a thermostat the sensor has to be placed in the "small" cycle! (the one which always flows water)

If you want to bring the pump up to a standstill you should position the sensor in a place where the coolant always gets hot even without the pump running.

(In normal operation this is not possible. See the advanced settings for this.)

### Use a thermostat or not?

It is possible to use the pump / controller in combination with or without an ordinary mechanical thermostat.

If you use one just make sure you set the controllers target temperature as close as possible to the temperature of the thermostat.

(Of course you can play with the target temperature a little for eventually better cooling results.)

A cooling system with a thermostat can benefit from an even shorter warm-up time and a more exact actual temperature.

A system without one on the other hand got fewer mechanical losses but the actual temperature can vary a bit more from the target you set.

### Removing the old mechanical water pump

Normally you would replace the old mechanical pump for the new one. So it is a good idea to remove the old one completely to lower the mechanical losses in your cooling system.

Sometimes it is not so easy to do that because of the way the belt drive was designed on your particular engine.

In this case you can help yourself by simply removing the impeller of your old pump and putting it back in place to use it as a simple pulley.

Of course you can use the new pump / controller in conjunction with the old mechanical one. This way the electrical one will act as a booster pump if the target temperature is set right.

### Tips and Tricks

It might be a good idea to rethink the whole cooling system while updating it to the new pump.

Many mechanical parts are not necessary anymore and perhaps could be removed or replaced.

Even a complete new way how or in what direction the cooling flows through the engine is possible.

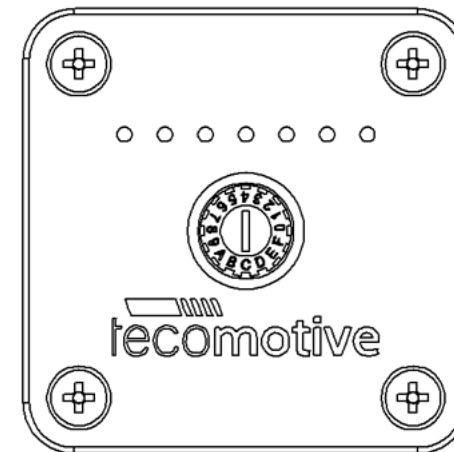

## Basic settings

### Basic settings

The controller is pre-programmed in a way that should work for most of the cars right out of the box.

The only things you need to decide is what target temperature and program you want to run. (See the list beside)

Turn the rotary switch to the associated character. Done.

### Using the rotary switch

Right in the center of the controller's front panel you'll find the rotary switch. By turning it to a specific character you are able to set up all the things the controller can do.

The character that points to the **bottom** is the currently selected one. (You will see a little white dot by looking closely.)

Use a little screwdriver for turning.

### Rotary switch position's

You can turn the switch to 16 different positions. Every one of them stands for a different program / target temperature.

Just choose the one that's best for your application from the following list.

If you don't know what target temperature would be the best for your engine, just choose one which is roughly the same as the temperature of the engines thermostat.

### Program list (Standard)

Pos.	Mode	Target Temperature	Description
0	Test mode	-	Pump Off / Fan Off
1	Test mode	-	Pump to min. rev. / Fan Off
2	Test mode	-	Pump to 50% / Fan Off
3	Test mode	-	Pump to 100% / Fan On
4	Normal mode	75°C / 167°F	At 5°C over target the radiator fan will come on.  The controlled temperature range is plus minus 5°C from the current target temperature.  The controller will exit the warm up mode at 10°C under target.
5	Normal mode	80°C / 176°F	
6	Normal mode	85°C / 185°F	
7	Normal mode	90°C / 194°F	
8	Normal mode	95°C / 203°F	
9	Normal mode	100°C / 212°F	
A	Pulsed mode	75°C / 167°F	
B	Pulsed mode	80°C / 176°F	
C	Pulsed mode	85°C / 185°F	
D	Pulsed mode	90°C / 194°F	
E	Pulsed mode	95°C / 203°F	
F	Pulsed mode	100°C / 212°F	

### General Information

In contrast to most stock systems the controller uses the cooling fan not only as an emergency but actively and early.

This is intended and strongly recommended to use.

If you turn the engine off while the coolant temperature is in the controlled range, the controller will perform a **delayed shutdown** of the pump and fan. This is a two-step process that runs for a maximum of two minutes. You find more information about this under "Advanced settings / Delayed shutdown" later in this manual.

### The Test mode

There is no active pump / temperature regulation in this mode.  
With the ignition key on, the controller will set the pump to a certain speed and will hold that until the ignition is turned back off.

This mode can be used for the first tests or bleeding purposes.

Rotary switch:

- **“0”** – The **pump and the radiator fan** are switched **off**.
- **“1”** – The **pump** will run with the setup **minimum pump value**.  
(see “Advanced settings / Minimum pump value”)  
The **radiator fan** is turned **off**.
- **“2”** – The **pump** will run at **50%**  
The **radiator fan** is turned **off**.
- **“3”** – **The pump will run at full speed.**  
**The radiator fan is turned on.**

### The Normal mode

In warm up condition (target minus 10°C) the controller will run the pump with the set minimum pump value.

(See “Advanced settings / Minimum pump value” for this.)

Once the coolant temperature reaches the controlled range (target plus minus 5°C), the controller will regulate the pump speed / temperature dynamically.

**This mode is mostly suitable for use with a mechanical thermostat.**

### The Pulsed mode

The only thing that differs in this mode is the way the warm-up phase is handled.

If the engine is cold, the controller will change the speed of the pump between the minimum pump value and another even lower value called “Pulse speed” in a timed cycle.

(See the chapters “Minimum pump value” and “Pulse speed” in the “Advanced settings” passage for more information on this.)

This way the engine will warm-up faster as in Normal mode.

**Therefore this mode is better suited for cooling systems without a mechanical thermostat.**

Once the warm-up phase is complete the controller will regulate the pump speed and temperature dynamically just as in the Normal mode.

**Info:** Of course you can use this mode for cooling systems with a thermostat, too. But the time the pump spends at “Pulse speed” could be a bit too long for this. So it might be a good idea to lower the value a bit. (See “Advanced settings / Pulse mode off-time” for more information on this.)

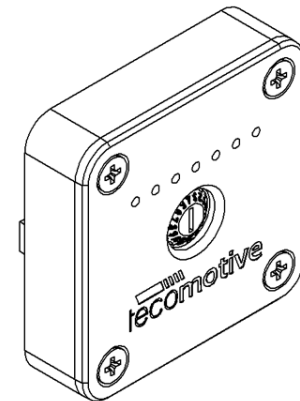

## Advanced settings

If the preset values the controller is using are not suitable for your application you are able to change the important ones with some advanced setup procedures.

The controller will then store all the changes to its onboard memory so that they are safe even if it loses power.

### The Setup procedure

To change any of the advanced settings you have to put in a four digit code under a certain condition with the rotary switch.

The code uses the numbers 0 – 4 – 2 – ... followed by a fourth digit that represents one of the following settings.

Setting / Code: (Order changed 08/2018 .. Expanded 01/2021)

- 0 – 4 – 2 – 0 >> Changes the program list and operation mode
- 0 – 4 – 2 – 1 >> Changes the minimum pump value
- 0 – 4 – 2 – 2 >> Virtual smaller pump (max. pump speed)
- 0 – 4 – 2 – 3 >> Switches the LED display
- 0 – 4 – 2 – 4 >> Switches the temperature sensor
- 0 – 4 – 2 – 6 >> Switches the delayed shutdown feature on or off
- 0 – 4 – 2 – 9 >> Switches the boost feature on or off
- 0 – 4 – 2 – A >> Fan mode and activation threshold
- 0 – 4 – 2 – C >> Changes the “On-time” the Pulsed mode uses
- 0 – 4 – 2 – D >> Changes the “Off-time” the Pulsed mode uses
- 0 – 4 – 2 – E >> Changes the “Pulse speed” the Pulsed mode uses
- 0 – 4 – 2 – F >> Reset to factory settings

### The Setup procedure step by step:

1. Disconnect the main battery connection from the controller. (e.g. by pulling the controllers plug)
2. Turn the rotary switch to the first digit of the code “0”.
3. Reconnect the main battery connection to the controller.
  - a. The LED in the middle lights up.
4. Turn the rotary switch to the second digit of the code “4”.
  - a. You got a 10 second time window to do so.
  - b. After those 10 seconds another LED will light up.
5. Turn the rotary switch to the third digit of the code “2”.
  - a. You got a 10 second time window to do so.
  - b. After those 10 seconds a third LED will light up.
6. Turn the rotary switch to the fourth digit of the code “0-F”.
  - a. You got a 10 second time window to do so.
  - b. After those 10 seconds the LED’s are going to flash twice and 5 LED will light up.
7. Now you have to turn the rotary switch to the new value of that particular setting. (You find a description of that in the relevant chapter in this manual)
  - a. You got a 20 second time window to change the setting.
  - b. After those 20 seconds the LED’s will flash several times to show you that the new value was saved correctly.
  - c. Afterwards the controller goes into normal operation.

**Info:** The ignition key does not have to be turned on for this.

**Tip:** If you plan on changing many settings you should consider putting a switch between the battery wire of the controller and your battery + line.

**Tip:** Write down the 4 digit code followed by the new settings value you want to change. This way you have a nice readable 5 digit code for each change.

Program list / Operating mode – Code „0“ (changed 01/2021)

In this setting you can change the program list from page 5 and operating mode of the controller.

With this change we brought the three previously separate firmware versions into one big one.

The following modes are available:

- **Engine Cooling I** - Select target temperatures from 75°C to 100°C (167°F to 212°F) in six steps each. (Standard)
- **Engine Cooling II** - Select target temperatures from 76°C to 91°C (169°F to 196°F) in six steps each.
- **Low Temperature I** - Select target temperatures from 15°C to 70°C (59°F to 158°F) in twelve steps each. Normal mode.
- **Low Temperature II** - Select target temperatures from 15°C to 70°C (59°F to 158°F) in twelve steps each. Pulsed mode.
- **EV Mode I** - Select target temperatures from 20° to 53°C (68°F to 127°F) in twelve steps each. Normal mode.
- **EV Mode II** - Select target temperatures from 20° to 53°C (68°F to 127°F) in twelve steps each. Pulsed mode.
- **Manual Mode I** - The controller controls the pump speed you have selected. Linear selectable speeds from 0 to 100% in 16 steps.
- **Manual Mode II** - The controller controls the pump speed you have selected. Exponential selectable speeds from 0 to 100% in 16 steps.

Possible settings: (Standard: Engine Cooling I)

**Procedure:**

In step 7 of the setup procedure, just choose one of the settings beside.

**E.g.:** If you want to switch to manual mode I.

The 5 digit code is:

“0” – “4” – “2” – “0” – “6”

(0420 for this menu and 6 for the new setting)

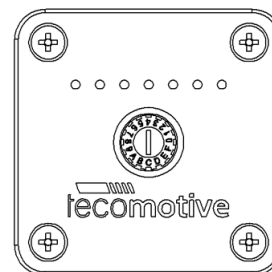

Stellung des Drehschalters	Betriebsmodus
- 0 -	Engine Cooling I (from 75° to 100°C)
1	Engine Cooling II (from 76° to 91°C)
2	Low Temperature I (from 15° to 70°C)
3	Low Temperature II (from 15° to 70°C)
4	EV Mode I (from 20° to 53°C)
5	EV Mode II (from 20° to 53°C)
6	Manual Mode Lin (no temperature control)
7	Manual Mode Exp (no temperature control)



Program lists of the available operating modes

Engine Cooling I (Standard) - „0“ - „4“ - „2“ - „0“ - „0“		
Pos.	Mode	Target temperature / Functions
0	Test mode	Pump Off / Fan Off
1	Test mode	Pump to min. rev. / Fan Off
2	Test mode	Pump to 50% / Fan Off
3	Test mode	Pump to 100% / Fan On
4	Normal mode	75°C / 167°F
5	Normal mode	80°C / 176°F
6	Normal mode	85°C / 185°F
7	Normal mode	90°C / 194°F
8	Normal mode	95°C / 203°F
9	Normal mode	100°C / 212°F
A	Pulsed mode	75°C / 167°F
B	Pulsed mode	80°C / 176°F
C	Pulsed mode	85°C / 185°F
D	Pulsed mode	90°C / 194°F
E	Pulsed mode	95°C / 203°F
F	Pulsed mode	100°C / 212°F

Low Temperature I - „0“ - „4“ - „2“ - „0“ - „2“		
Pos.	Mode	Target temperature / Functions
0	Test mode	Pump Off / Fan Off
1	Test mode	Pump to min. rev. / Fan Off
2	Test mode	Pump to 50% / Fan Off
3	Test mode	Pump to 100% / Fan On
4	Normal mode	15°C / 59°F
5	Normal mode	20°C / 68°F
6	Normal mode	25°C / 77°F
7	Normal mode	30°C / 86°F
8	Normal mode	35°C / 95°F
9	Normal mode	40°C / 104°F
A	Normal mode	45°C / 113°F
B	Normal mode	50°C / 122°F
C	Normal mode	55°C / 131°F
D	Normal mode	60°C / 140°F
E	Normal mode	65°C / 149°F
F	Normal mode	70°C / 158°F

Engine Cooling II - „0“ - „4“ - „2“ - „0“ - „1“		
Pos.	Mode	Target temperature / Functions
0	Test mode	Pump Off / Fan Off
1	Test mode	Pump to min. rev. / Fan Off
2	Test mode	Pump to 50% / Fan Off
3	Test mode	Pump to 100% / Fan On
4	Normal mode	76°C / 169°F
5	Normal mode	79°C / 174°F
6	Normal mode	82°C / 180°F
7	Normal mode	85°C / 185°F
8	Normal mode	88°C / 190°F
9	Normal mode	91°C / 196°F
A	Pulsed mode	76°C / 169°F
B	Pulsed mode	79°C / 174°F
C	Pulsed mode	82°C / 180°F
D	Pulsed mode	85°C / 185°F
E	Pulsed mode	88°C / 190°F
F	Pulsed mode	91°C / 196°F

Low Temperature II - „0“ - „4“ - „2“ - „0“ - „3“		
Pos.	Mode	Target temperature / Functions
0	Test mode	Pump Off / Fan Off
1	Test mode	Pump to min. rev. / Fan Off
2	Test mode	Pump to 50% / Fan Off
3	Test mode	Pump to 100% / Fan On
4	Pulsed mode	15°C / 59°F
5	Pulsed mode	20°C / 68°F
6	Pulsed mode	25°C / 77°F
7	Pulsed mode	30°C / 86°F
8	Pulsed mode	35°C / 95°F
9	Pulsed mode	40°C / 104°F
A	Pulsed mode	45°C / 113°F
B	Pulsed mode	50°C / 122°F
C	Pulsed mode	55°C / 131°F
D	Pulsed mode	60°C / 140°F
E	Pulsed mode	65°C / 149°F
F	Pulsed mode	70°C / 158°F

Program lists of the available operating modes

EV Mode I - „0“ – „4“ – „2“ – „0“ – „4“		
Pos.	Mode	Target temperature / Functions
0	Test mode	Pump Off / Fan Off
1	Test mode	Pump to min. rev. / Fan Off
2	Test mode	Pump to 50% / Fan Off
3	Test mode	Pump to 100% / Fan On
4	Normal mode	20°C / 68°F
5	Normal mode	23°C / 73°F
6	Normal mode	26°C / 79°F
7	Normal mode	29°C / 84°F
8	Normal mode	32°C / 90°F
9	Normal mode	35°C / 95°F
A	Normal mode	38°C / 100°F
B	Normal mode	41°C / 106°F
C	Normal mode	44°C / 111°F
D	Normal mode	47°C / 117°F
E	Normal mode	50°C / 122°F
F	Normal mode	53°C / 127°F

Manual Mode Linear - „0“ – „4“ – „2“ – „0“ – „6“		
Pos.	Pump Speed	Fan Output
0	Stop	Fan is off
1	< 3%	
2	7 %	
3	14%	
4	21%	
5	28 %	
6	35 %	
7	42 %	
8	50 %	
9	58 %	
A	65 %	
B	72 %	
C	79 %	
D	86 %	
E	93 %	
F	100 %	Fan is on

EV Mode II - „0“ – „4“ – „2“ – „0“ – „5“		
Pos.	Mode	Target temperature / Functions
0	Test mode	Pump Off / Fan Off
1	Test mode	Pump to min. rev. / Fan Off
2	Test mode	Pump to 50% / Fan Off
3	Test mode	Pump to 100% / Fan On
4	Pulsed mode	20°C / 68°F
5	Pulsed mode	23°C / 73°F
6	Pulsed mode	26°C / 79°F
7	Pulsed mode	29°C / 84°F
8	Pulsed mode	32°C / 90°F
9	Pulsed mode	35°C / 95°F
A	Pulsed mode	38°C / 100°F
B	Pulsed mode	41°C / 106°F
C	Pulsed mode	44°C / 111°F
D	Pulsed mode	47°C / 117°F
E	Pulsed mode	50°C / 122°F
F	Pulsed mode	53°C / 127°F

Manual Mode Exponential - „0“ – „4“ – „2“ – „0“ – „7“		
Pos.	Pump Speed	Fan Output
0	Stop	Fan is off
1	< 3%	
2	4 %	
3	5%	
4	6%	
5	8 %	
6	10 %	
7	13 %	
8	17 %	
9	22 %	
A	29 %	
B	37 %	
C	47 %	
D	61 %	
E	78 %	
F	100 %	Fan is on

### Minimum pump value – Code “1”

In this setting you can change the minimum speed of the pump the controller will allow.

The factory setting here is 25% or about 30 liters per minute (1200 rpm) which is roughly the same a mechanical pump would perform if the engine is in idle. (The numbers apply only to the CWA200)

The pump itself (CWA200) is able to deal with speeds from 18 up to 4500 revolutions per minute. This relates to a flow rate from 0.5 to 116 liters per minute or 8 to 1839 gallons per hour.

Keep in mind that there should always be enough flow so the temperature sensor is able to measure the coolant temperature correctly.

The right amount of minimum flow is tricky to find out. Feel free to experiment a little with this setting but always observe the actual temperature.

#### Possible settings:

In step 7 of the setup procedure, just choose one of the settings beside.

**E.g.:** If you want to change the setting to 15% the 5 digit code is: “0” – “4” – “2” – “1” – “3” (0421 for this menu and 3 for the new setting)

Rotary switch position	rpm (CWA200)	%
0	100	3
1	200	5
2	450	10
3	700	15
4	900	20
5	1400	30
6	1800	40
7	2300	50
8	2700	60
9	3200	70

### Virtual smaller pump – Code “2” (since Sept. 2017)

In some cases it is possible that the pump is actually too fast for a certain cooling system. This can have negative effects on the temperature and some parts of the system.

If that is the case you can slow down the pump with this value.

It acts as if you would have a smaller pump by a certain percentage. So it limits the maximum speed and adjusts the controlling algorithm accordingly.

In step 7 of the setup procedure, just choose one of the settings beside.

**E.g.:** If you want to limit the pump to 80 percent. The 5 digit code is: “0” – “4” – “2” – “2” – “2” (0422 for this menu and 2 for the new setting)

Rotary switch position	Reduction to ...
- 0 -	100 %
1	90 %
2	80 %
3	70 %
4	60 %
5	50 %

The factory setting here is 100% (full speed).

#### **Attention:**

**The test and manual mode is not part of this function.**

**So 100% in test mode means real 100% pump speed.**

### LED Display – Code „3“

There is a seven LED display right above the rotary switch.  
In factory setting this will show you the actual speed of the pump.

You can change this so that it shows the *rough* coolant temperature.  
The middle LED stands for the set target temperature and the neighboring LEDs for plus or minus 5 degrees Celsius.

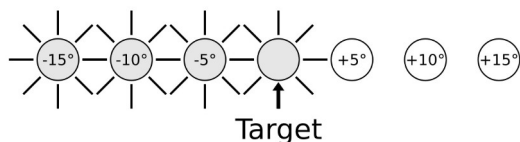

In “test mode” the pump speed is shown. (always)

In step 7 of the setup procedure, just choose one of the settings beside.

**E.g.:** If you want to change the display to show the coolant temperature.

The 5 digit code is: “0” – “4” – “2” – “3” – “1”  
(0423 for this menu and 1 for the new setting)

The factory setting here is: “0” – Speed of the pump

#### **Attention:**

In the manual program lists (page 8/10 - manual mode I + II), the display takes place in 10 degree steps from 10 degrees Celsius to 70 degrees Celsius. (1 LED = 10 ° / 7 LED = 70 °)

Rotary switch position	LED Display
- 0 -	Speed of the pump
1	Coolant temperature

### Temperature Sensor – Code „4“

The temperature sensor supplied is a derivative of the Bosch NTC M12.  
But sometimes it is useful to be able to switch to another sensor.  
Here you can choose between three different sensor characteristics.

#### **Standard:** Bosch NTC M12 (M12x1,5)

- Part number: 0 280 130 026 (and compatible)
- Compatible to VW G62 / VW 026906161 / Bosch 0 280 130 040
- Resistance at 0°C: 5896 Ohm
- Resistance at 20°C: 2500 Ohm
- Resistance at 80°C: 323 Ohm

#### **Option 1:** General Motors (Standard TX3)

- Part number: GM 10045847, 12146312, 15326386, ...
- Delphi TS10011, TS10075 / Borg Warner WT3000 / Wells SU109
- Resistance at 0°C: 9335 Ohm
- Resistance at 20°C: 3500 Ohm
- Resistance at 80°C: 336 Ohm

#### **Option 2:** Mercedes/VW (IAT)

- Part number: MB 0005422818, 6511530028 / VW 2D0905379A, ...
- Bosch 1287213607 / Hella 6PT 009 109-291 / Jeep K05149209AA
- Resistance at 20°C: 6050 Ohm
- Resistance at 40°C: 2600 Ohm
- Resistance at 80°C: 625 Ohm

In step 7 of the setup procedure, just choose one of the settings beside.

Rotary switch position	Temperature sensor
- 0 -	Bosch/VW
1	General Motors
2	Mercedes

**E.g.:** If you want to use the GM Sensor. The 5 digit code is:

„0“ – „4“ – „2“ – „4“ – „1“

(0424 for this menu and 1 for the new setting)

### Delayed shutdown – Code “6”

After the ignition key is turned off the controller will check the coolant temperature once again. If it is still in the controlled range the delayed shutdown mode will kick in.

This mode is divided into two steps of one minute each.

In the first minute the pump will go to its full speed and the radiator fan will come on.

In the second step the pump speed is reduced to about 50% and the radiator fan is turned off again.

After that or if the coolant temperature falls down below the controlled range, the delayed shutdown feature will quit and the controller / pump will go into standby mode.

If you don't need or want this feature you can deactivate it.

By doing so, the controller / pump will go directly into standby mode if the ignition key is turned off.

In step 7 of the setup procedure, just choose one of settings beside.

Rotary switch position	Delayed shutdown
0	Off
- 1 -	On

**E.g.:** If you want to deactivate the delayed shutdown the 5 digit code is: “0” – “4” – “2” – “6” – “0” (0426 for this menu and 0 for the new setting)

### Boost Feature – Code „9“

To calculate the optimal pump speed the controller is measuring not only the current coolant temperature but also looks at how fast the temperature is rising.

If the temperature rises too fast to counteract with the normal control algorithm the controller will boost the pumps speed to its maximum in order to get it under control.

But in some few cases this can cause a saw tooth like effect where the pumps speed is quickly changing from high to low and back again.

If this happens you could deactivate this feature.

In step 7 of the setup procedure, just choose one of the settings beside.

Rotary switch position	Boost Feature
0	Off
- 1 -	On

**E.g.:** If you want to deactivate the Boost feature the 5 digit code is: “0” – “4” – “2” – “9” – “0” (0429 for this menu and 0 for the new setting)

The factory setting here is “On”.

Fan activation threshold and mode – Code “A” (Update 06/2020)

In some cases the standard activation of the fan output at 5 degrees C above target temperature can cause problems.

In that case it is possible to set it to one of the following values.

(Setting 0 to 5)

**Beta:** *It is also possible to control a 10Hz PWM fan via the tinyCWA’s fan output. These can be found in some Mercedes models.*

*In this case the fan will be switched on gradually if the set temperature threshold (above target) is reached. (Settings A to F)*

Possible Settings:

In step 7 of the setup procedure, just choose one of the settings beside.

**E.g.:** If you want to set the threshold to 10 degrees C above the target temperature the 5 digit code is: “0” - “4” - “2” - “A” - “5” (042A for this menu and 5 for the new setting)

Rotary switch position	Fan threshold above target	Fan Mode
- 0 -	5° C	Relay
1	6° C	Relay
2	7° C	Relay
3	8° C	Relay
4	9° C	Relay
5	10° C	Relay
<i>Warning: This PWM mode is intended mainly for the Mercedes community and has not been tested, yet. (Beta Status)</i>		
A	1° C	PWM
B	2° C	PWM
C	3° C	PWM
D	4° C	PWM
E	5° C	PWM
F	6° C	PWM

The factory setting here is: “0” - 5 degrees C above the target temperature

Pulsmodus Ontime – Code „C“

The Pulsed mode is explained on page 6 of this manual.

The “Ontime” describes how long the controller will hold the “Minimum pump value” in the Pulsed mode warm-up cycle.

The factory setting here is about 3 seconds to circulate the coolant just enough for a quick but safe warm-up.

If this setting doesn’t work for you, you can of course change it.

Possible settings:

In step 7 of the setup procedure, just choose one of the settings beside.

**E.g.:** If you want to change the Ontime to 10 seconds the 5 digit code is: “0” - “4” - “2” - “C” - “2” (042C for this menu and 2 for the new setting)

Rotary switch position	Ontime in seconds
- 0 -	3
1	5
2	10
3	15
4	20
5	25
6	30
7	35
8	40
9	45

### Pulsmodus Offtime – Code „D“

The Pulsed mode is explained on page 6 of this manual.

The “Offtime” describes how long the controller will hold the “Pulse speed” in the Pulsed mode warm-up cycle.

The factory setting here is about 30 seconds to circulate the coolant just enough for a quick but safe warm-up.

If this setting doesn’t work for you, you can of course change it.

#### Possible settings:

In step 7 of the setup procedure, just choose one of the settings beside.

**E.g.:** If you want to change the Offtime to 10 seconds the 5 digit code is:  
“0” – “4” – “2” – “D” – “2”  
(042D for this menu and 2 for the new setting)

Rotary switch position	Offtime in seconds
0	3
1	5
2	10
3	15
4	20
5	25
- 6 -	30
7	35
8	40
9	45

### Pulse speed – Code „E“

The Pulsed mode is explained on page 6 of this manual.

The “Pulse speed” is the pump speed the controller will set in the “Offtime” cycle of the Pulsed mode warm-up.

The factory setting here is about 8% to ensure a quick and safe warm-up.

#### Possible settings:

In step 7 of the setup procedure, just choose one of the settings beside.

**E.g.:** If you want to change the Pulse speed to 700 rpm the 5 digit code is:  
“0” – “4” – “2” – “E” – “3”  
(042E for this menu and 3 for the new setting)

Rotary switch position	rpm (CWA200)	%
0	100	3
1	200	5
2	450	10
3	700	15
4	900	20
5	1400	30
6	1800	40
7	2300	50
8	2700	60
9	3200	70
<b>D</b>	<b>0</b>	<b>Pump OFF</b>

### **!!! Attention !!!**

*It is possible to get the pump to a **complete stand still** with the “D” setting. In this case there will be **no coolant flow** whatsoever, the sensor will only be able to measure the temperature at the spot it’s sits in and the **possibility for building hot spots** in the cooling system is very high!*

*You should only use this setting if you know what you’re doing! We cannot be held liable for any **damages on your car, engine** or whatsoever!*

## Reset to factory settings – Code „F“

You can always reset the whole controller to its factory settings.

In step 7 of the setup procedure, just choose the “1” for this.

The controller will then overwrite all the previous settings with the ones in the table below.

So the 5 digit code for this is:

“0” – “4” – “2” – “F” – “1”

(042F for this menu and 1 for the reset)

Factory settings:

Name	Setting
Program list (op. mode)	Engine Cooling I (Standard)
Minimum pump value	25% or 1200 rpm (CWA200)
Virtual smaller pump	100% (full speed)
LED Display	Displays the speed of the pump
Temperature Sensor	Bosch NTC M12
Delayed shutdown	Delayed shutdown activated
Boost feature	Boost feature activated
Fan activation threshold	5 degrees above target
Pulsed mode Ontime	3 seconds
Pulsed mode Offtime	30 seconds
Pulse speed	8% or 360 rpm (CWA200)

## **Additional Information**

### Warnings and safety functions of the controller

The tinyCWA is showing not only the pumps speed or the temperature via its LED, it is also giving you some other information and warnings.

**Fan is on:** (one deactivated LED runs from left to right)

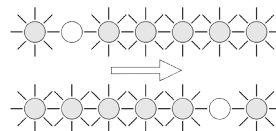

**Fan is on in Temperature LED mode:** (LED 7 turns on)

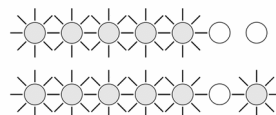

**The temperature is 10°C above the fan activation threshold:**

(all LED blink)

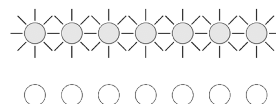

**Temperature sensor error:** (an LED pattern blinks)

This error shows if no sensor is found or the sensor has a short circuit.

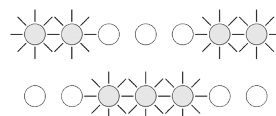

The pumps speed is upped to 100% and the fan is turned on with this error code.

This is to prevent any engine damage due to overheating.



### Specifications Controller

Name: Tecomotive "tinyCWA"  
Dimensions: about 44x44x12mm (without connector)  
about 44x44x24mm (with connector)  
Operating voltage: 8 to 16 Volts  
Current consumption: 20mA max.  
about 1.5mA in standby mode  
Temperature range: -40°C to +80°C (-40°F to +176°F)  
Weight: about 40 grams (1.4 ounces)

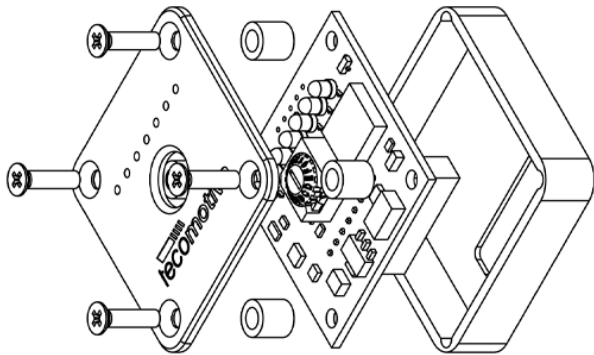

### Specifications water pumps

#### CWA50

Name: Pierburg "CWA50"  
Dimensions: about 100x100x123mm  
Operating voltage: 8 to 16 Volt  
Stromaufnahme: max. 6,6A im Betrieb  
ca. 0,2mA im Standby  
Speed: 20 bis 5800 rpm  
Nominal diff. pressure: 0.55 bar  
Flow rate: 25 l/min @ 0.6 bar / 35 l/min @ 0.3 bar  
Temperature range: -40°C to +140°C  
Protection: IP67

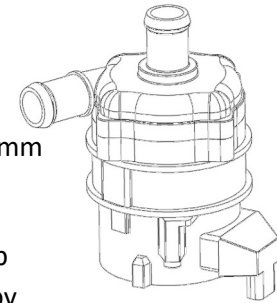

#### Part numbers:

Pierburg: 7.01360.15.0 / 7.06033.15.0 /  
7.06033.31.0 / 7.06033.32.0 / ...  
BMW: 11 51 7 566 335 / ...  
Audi: 8K0965567B / 8K0965569 / ...

### CWA100

Name: Pierburg „CWA100“  
Dimensions: about 100x100x123mm  
Operating voltage: 8 to 16 Volt  
Current consumption: 8.5A max.  
about 0.2mA in standby mode

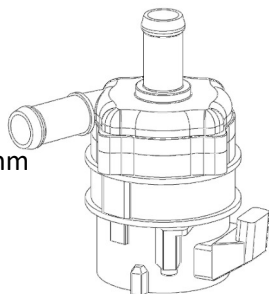

Nominal diff. pressure: 0.85 bar  
Flow rate: 30 l/min @ 0.85 bar / 40 l/min @ 0.65 bar  
Temperature range: -40°C to +120°C  
Protection: IP67

### Part numbers:

Pierburg: 7.06754.05.0 / 7.04934.54.0 / ...  
Mercedes: A 000 500 04 86 / ...  
VW: 4N0965567 / ...

### CWA150

Name: Pierburg „CWA150“  
Dimensions: about 100x100x130mm  
Operating voltage: 9 to 16 Volt  
Current consumption: 15A max.  
about 0.2mA in standby mode

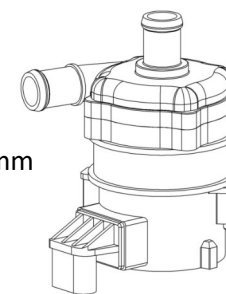

Nominal diff. pressure: 1.40 bar  
Flow rate: 29 l/min @ 1.4 bar / 40 l/min @ 0.80 bar  
Temperature range: -40°C to +100°C  
Schutzart: IP54

### Part numbers:

Pierburg: 7.09578.00.0  
VW: 4KE965567B

## CWA200

Name: Pierburg "CWA200"  
Dimensions: about 100x125x175mm  
Operating voltage: 8 to 16 Volt  
Current consumption: 16.5A max. (typical 15A)  
about 0.2mA in standby mode  
Speed: 20 to 4500 rpm  
Nominal diff. Pressure: 0.45 bar  
Flow rate: 116 l/min @ 0.45 bar / 166 l/min @ 0.3 bar  
Temperature range: -40°C to +140°C  
Protection: IP67

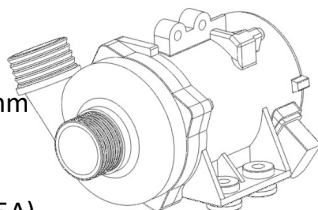

### Part numbers:

Pierburg: 7.00294.17.0 / 7.02478.40.0  
7.02478.22.0 / 7.00294.15.0  
7.02851.20.8 / 7.02851.20.0  
BMW: 11 51 7 586 925 / 11 51 7 563 183  
11 51 7 546 994 / 11 51 7 521 584  
11 51 7 545 201 / 11 51 7 586 924  
11 51 7 586 929 / 11 51 7 583 836  
11 51 7 586 928 / ...

## CWA400

Name: Pierburg "CWA400"  
Dimensions: about 100x125x175mm  
Operating voltage: 8 to 16 Volt  
Current consumption: 36A max.  
about 0.2mA in standby mode  
Speed: 20 to 6000 rpm  
Nominal diff. Pressure: 0.85 bar  
Flow rate: 150 l/min @ 0.85 bar / 220 l/min @ 0.55 bar  
Temperature range: -40°C to +140°C  
Protection: IP67

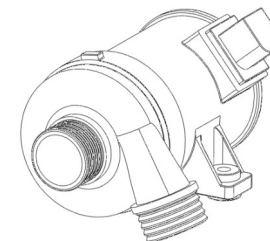

### Part numbers:

Pierburg: 7.03665.66.0 / 7.02881.66.0  
7.02881.31.0 / ...  
BMW: 11 51 7 604 027 / 11 51 8 635 090  
11 51 7 596 763 / 11 51 8 635 089

## Safety notes

### Disclaimer

The installation should only be done by experienced or special trained personnel with the necessary knowledge.

We cannot be held liable for any damages on your car, engine or the product itself!

### General notes

Before you plug in the devices make sure all the cables are wired correctly!

The installation needs special automotive and electrical knowledge. Improper connection and use can damage your car, the engine or the product itself.

### Installation

Before you start with the installation disconnect the cars battery to prevent any unintentional short circuits.

Pay attention to any potential safety notes from your car manufacturer. (E.g. regarding airbags, alarm systems, ECU's or immobilizers)

Avoid smoking, fire, flying sparks or static electricity charges.

Be careful not to damage any parts (e.g. battery, wires, hoses...) while drilling holes.

Don't lay cables or connectors in areas which are exposed to spray water.

Don't mount the wires / sensor in areas which are exposed to moving or rotating parts.

### Operation

Any modifications on your car could be against the law.

It is your responsibility to get all the necessary information and permissions to drive the car legally.

If you drive your car without proper legality and permissions you could lose your insurance coverage and could be committing a criminal offense.

### Current consumption over longer periods of time

The devices are consuming a little bit of current even in standby mode.

If you don't use them over a longer period of time it is recommended to disconnect them entirely to not damage the cars battery.

### Application

The device described in this manual is only tested with the CWA type water pumps made by the "Pierburg Pump Technology GmbH" which are for instance available at the replacement department of the "BMW AG".

A functional guarantee can only be given by using this products.

## Connection Diagrams

